

OIIIIT



SERIE **SF - SP** SERIES

Filtri in aspirazione immersi
Suction strainers

serie spaccalegna / for log splitters



ОАО "Белпромимпэкс"

www.bpi-hydro.by
gidro@bpi.by

Контакты:

Тел./факс: (017) 346-80-64

Моб. Velcom: (029) 102-14-14

Con il fine di migliorare costantemente la qualità dei nostri prodotti, ci riserviamo il diritto di modificarne in qualsiasi momento le caratteristiche senza preavviso.

È responsabilità della spettabile clientela la costante verifica dei dati contenuti nei cataloghi.

Questo catalogo annulla e sostituisce i precedenti.

In order to constantly improve our products quality, we take the right to make changes to the catalogues at any time without notice.

Customers have the responsibility to continuously check all the information in the catalogues.

This catalogue cancels and replaces the previous ones.

I filtri della serie SF - SP sono stati studiati per essere montati sulla linea di aspirazione completamente immersi nel serbatoio. I filtri della serie SF - SP sono disponibili con o senza valvola di By-pass.

The filters of our series SF, SP, have been developed for use in the suction line. They work completely immersed in the reservoir. Series "SF" and "SP" are available both with and without bypass valve.

Materiali / Materials

Serie Series	Attacco Cap	Fondello Bottom Cap	Tubi di sostegno Tube	Valvole di by-pass Bypass valve
SF	Lega di alluminio Aluminium alloy	Acciaio zincato Zinc plated steel	Acciaio zincato Zinc plated steel	Nylon caricato Reinforced Nylon
SP	Nylon caricato Reinforced Nylon	Nylon caricato/Acciaio zincato Reinforced Nylon/Zinc plated steel	Acciaio zincato Zinc plated steel	Nylon caricato Reinforced Nylon

Setti filtranti / Filtration Media

Tipo Type	Descrizione Description	Materiale Materials	Grado di filtrazione Filtration degree
R 060	Rete a maglia quadra Square mesh	Aisi 304	60 µm
R 090	Rete a maglia quadra Square mesh	Aisi 304	90 µm
R 250	Rete a maglia quadra Square mesh	Aisi 304	250 µm

Il grado di filtrazione delle reti si esprime come il diametro max della sfera inscritta nella luce della maglia.

The filtration ratings indicated by the type number which indicates the diameter (in micrometers or microns) of the largest spherical particle which will pass through the mesh.



CONDIZIONI DI ESERCIZIO

WORKING CONDITIONS

Pressioni: Valvola di By-pass tarate a 0,25 bar \pm 9%

(solo per le serie SF-SP)

Set point of bypass valve: The bypass valves are set to 0,25 bar \pm 9%
(series SF-SP only)

Temperature: Temperatura massima di esercizio da -25°C a +90°C

Temperature range: Working temperature: -25°C / +90°C

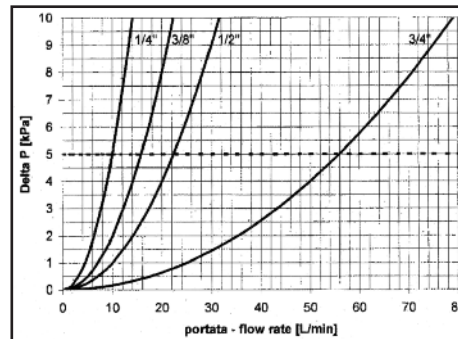

Compatibilità con i liquidi - ISO 2943: Compatibili con oli minerali
(tipo HH, HM, HR, HV, HG
secondo ISO 6743/4)

Fluid compatibility: Compatible with standard mineral oils
(types HH, HM, HR, HV, HG
according to ISO 6743/4)

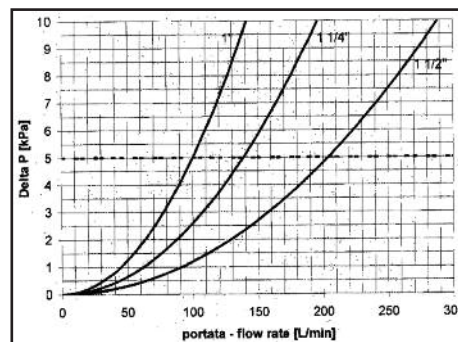

Perdite di carico del filtro completo: Le cadute di pressione nei filtri
completi sono riferite a olio
minerale avente massa volumica
di 860 kg/m³ e viscosità
cinematica di 30 mm²/s (cSt).
La caduta di pressione massima
a filtro pulito deve
essere \leq 5 kPa.

Complete filter pressure drop: The graphics refer to use of mineral oil
with a mass density of 860 kg/m³
and kinematic viscosity of 30 mm²/s (cSt).
The clean filter pressure drop shall be
 \leq 5 kPa

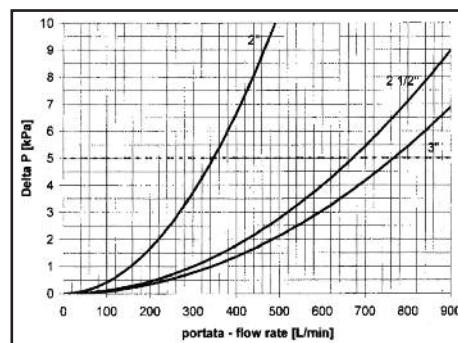

100kPa= 1 bar



ОАО "Белпромимпэкс"

www.bpi-hydro.by
gidro@bpi.by

Контакты:

Тел./факс: (017) 346-80-64

Моб. Velcom: (029) 102-14-14

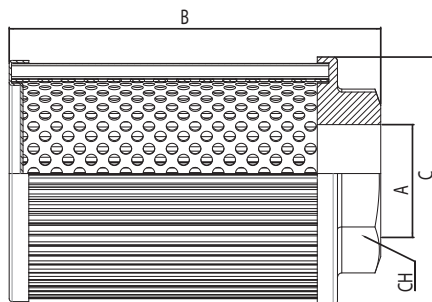

SF - SP			SF		SP		L/min	
TIPO	A	B	C	CH	C	CH		
046A	014	1/4"	90	46	30	43	25	5
	038	3/8"				46/50***	30/26***	10
	012	1/2"						14
046B	014	1/4"	105	46	30	43	25	5
	038	3/8"				46/50***	30/26***	10
	012	1/2"						14
064A	012	1/2"	109	64	36	64	36	14
	034	3/4"			46		46	25
	100	1"			46		46	45
064B	012	1/2"	139	64	36	64	36	14
	034	3/4"			46		46	25
	100	1"			46		46	45
086A	100	1"	139	86	60	86	60	45
	114	1 1/4"				86/88***	60/50***	62
	112	1 1/2"						86
	200	2"				70	70	116
086B	100	1"	220	86	60	86	60	45
	114	1 1/4"				86/88***	60/50***	62
	112	1 1/2"						86
	200	2"				70	70	116
086C	100	1"	260	86	60	86	60	45
	114	1 1/4"				86/88***	60/50***	62
	112	1 1/2"						86
	200	2"				70	70	116
086D	100	1"	331	86	60	86	60	45
	114	1 1/4"				86/88***	60/50***	62
	112	1 1/2"						86
	200	2"				70	70	116
150A	112	1 1/2"	151	150	70	150	70	90
	200	2"			90		90	116
	212	2 1/2"			100		100	270
	300	3"			100		100	400
150B	112	1 1/2"	211	150	70	150	70	90
	200	2"			90		90	116
	212	2 1/2"			100		100	270
	300	3"			100		100	400
150C	112	1 1/2"	272	150	70	150	70	90
	200	2"			90		90	116
	212	2 1/2"			100		100	270
	300	3"			100		100	400

*** dipendente dalla disponibilità / dependant on the availability

SF 150B 212 G R090 V

Serie Series	Codice - Part Number		A - Thread size "A"	
			BSP	NPT
SF	046	A	014	1/4"
SP		B	038	3/8"
		B	012	1/2"
064	A	012	1/2"	
	B	034	3/4"	
		100	1"	
086	A	100	1"	
	B	114	1 1/4"	
		C	112	1 1/2"
	D	200	2"	
150	A	112	1 1/2"	
		200	2"	
	B	212	2 1/2"	
		C	300	3"

Filettatura Thread	
G	Filetto BSP Thread BSP
N	Filetto NPT Thread NPT Disponibile solo per serie SF Available only for SF series

By-pass	
V	senza by-pass without by-pass
V	con by-pass with by-pass

Nota bene - I filtri SF/SP sono venduti in confezioni da:
Please note - Filters SF/SP are sold in packs of:

046	12 pz
064	6 pz
086	6 pz
150	1 pz

Tipo Type	Descrizione Description	Gradi di filtrazione Filtration rating
R 060	Rete a maglia quadra (Aisi 304) Square mesh (Aisi 304)	60 µm
R 090	Rete a maglia quadra (Aisi 304) Square mesh (Aisi 304)	90 µm
R 250	Rete a maglia quadra (Aisi 304) Square mesh (Aisi 304)	250 µm



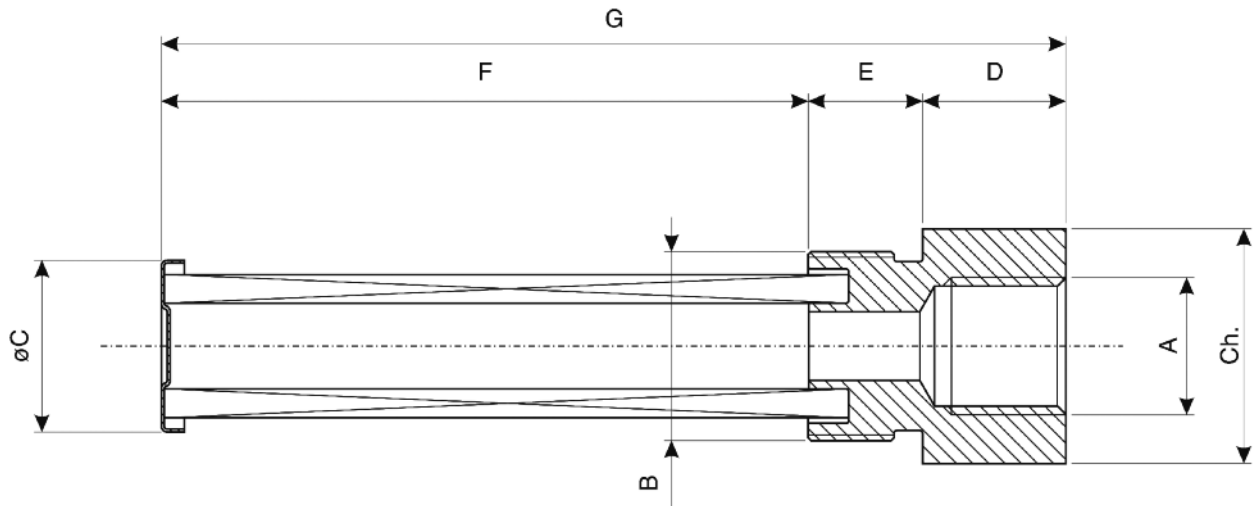

Tipo Type	OMT - 03918	OMT - 03912	OMT - 03901	OMT - 02496	OMT - 02492	OMT - 02490
A	1/2"	3/4"	1/2"	3/4"	1/2"	1/2"
B	3/4"	1"	1"	1"	1"	1"
C	21	30	30	30	30	30
D	23	29	29	29	29	29
E	14	16	16	16	16	16
F	112	120	100	120	160	120
G	149	165	145	165	205	165
Grado di filtrazione Filtration ratio	230/250 Micron	90/110 Micron	250/270 Micron	250/270 Micron	250/270 Micron	250/270 Micron
Ch	30	40	40	40	40	40



SCAMBIATORI
HEAT EXCHANGERS

FILTRI
FILTERS

ACCESSORI
ACCESSORIES

COMPONENTI
COMPONENTS

FLANGE / FLANGES
RACCORDI / COUPLINGS
BLOCCHI / MANIFOLDS

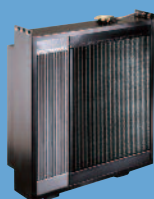
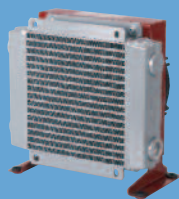

ОАО "Белпромимпэкс"

www.bpi-hydro.by
gidro@bpi.by

Контакты:

Тел./факс: (017) 346-80-64

Моб. Velcom: (029) 102-14-14